

Thank you for purchasing a Futaba GV-1 governor.

To ensure safe use, please read this manual thoroughly before using your new governor. After reading this manual, store it in a safe place.

The GV-1 is an engine governor for model helicopters.

The governor automatically maintains constant rotor R.P.M. due to load changes (reaction to torque) by suppressing variations in the engine speed. The GV-1 works very well in all maneuvers, from hovering to flying.

- Engine speed can be set from both the GV-1 and the transmitter.
- A magnetic sensing system reads the engine speed.
- Fuel mixture control can be set.
- An LCD panel displays the engine speed and set data.

PRECAUTIONS 6

- Definition of symbols 6
- Setting precautions 7
- Operating precautions 9

BEFORE USE 10

- Set contents 10
- Nomenclature 11
- Overview of GV-1 operation 12
- Examples 14

ASSEMBLY & ADJUSTMENT 16

- Mounting the magnet and sensor 16
- GV-1 connections 21
- Fuselage setting precautions 22

FUNCTIONS 24

- LCD display and edit keys 24
- Low battery alarm 24
- Function map 25
- Initial setting for governor operation 26
- Description of functions 33

REFERENCE 47



- Specifications 47
- Glossary 48
- GV-1 PARAMETERS SHEET 49
- REPAIR SERVICE 50

To ensure safe use, please observe the following precautions.



Definition of symbols

Pay close attention to the parts of this manual indicated by the following symbols.

PRECAUTIONS

Symbol	Meaning
 Danger	Indicates a procedure that could result in serious injury or death to the user or other persons if ignored and not performed properly.
 Warning	Indicates a procedure that could result in death or serious injury to the user or other persons, as well as physical damage, if ignored and not performed properly.
 Caution	Indicates a procedure that may result in serious injury to the user or other persons, or physical damage only, if ignored and not performed properly.

Graphic symbols

-  ; Operations that must not be performed.
-  ; Operations that always must be performed.

Setting precautions

 **Warning**

 When using the GV-1 for the first time, or when making changes in the throw of a servo, always perform the limit setting operation.
(Setting method: Page 45)

 Always set battery fail safe function at the GV-1.
(Setting method: Page 44)

Since the GV-1, when used, controls the throttle, the battery fail safe function that is in a PCM transmitter will not be used.

 Because the GV-1 controls the throttle, the throttle channel fail safe function normally set in a PCM transmitter will not be used. Set the fail safe function as described below.

Transmitter setting

Use the fail safe function for the channel that turns the governor on and off to set the fail safe position to the point at which the governor is turned off. With this setting, when the system enters the fail safe state, the governor will be turned off and the receiver throttle signal will be output directly.

PRECAUTIONS

⚠ Caution

⚠ The center of the sensor is different from the center of the sensor case so be careful when mounting the sensor. (Setting method: Page 16)

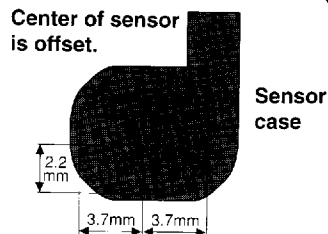

When using the PCM1024Z transmitter

When using the condition hold (CHD) function, always set the throttle servo maximum operating point (MAX THR) to 20% or less.

Depending on the conditions, this setting will turn on the governor and prevent the engine from exceeding the set speed even when condition hold is set.

(Governor ON conditions)

The following conditions must be performed, to turn on the governor:

- Governor ON/OFF switch set to ON position.
- Throttle stick set to 20% or more from slow position.
- Engine speed raised to 70% or more of set speed.

Operating precautions

⚠ Caution

⚠ At the beginning of flight, keep the governor in the OFF state by setting the throttle stick to no more than 20% from the slow side.

While the engine is running, turn on the governor at the point which the throttle stick is at least 20% from the slow side and the engine speed exceeds 70% of the set speed.

⚠ When the model is on the ground, lower the pitch to the position at which the model does not try to lift off. Do not take your eyes off the model.

When the governor operates and the rotor speed increases the lift also increases causing the model to try lift off, depending on the pitch position.

⚠ Periodically check the sensor output. (Check method: Page 46)

The magnet rotates at high speed and is subjected to a large centrifugal force. Check the sensor output and mounting state about once every 10 flights.

⚠ If the model begins to shake during operation, immediately turn off the governor. (See "Governor on/off operation mode setting" on page 29.)

When engine speed is not stable at high R.P.M.'s

The carburetor design, etc. may cause the engine to operate unstable. If this occurs, lower the maximum speed setting to the range over which there is no problem.

Governor GV-1

BEFORE USE

Set contents

Immediately upon opening the carton, check if the following items are supplied.

GV-1 control amp

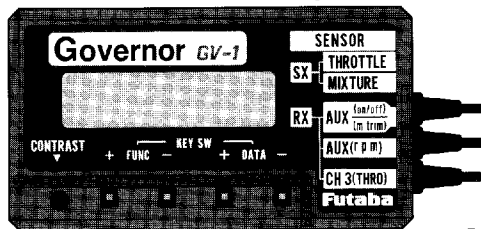

Magnet



GV-1 magnetic sensor



Seal

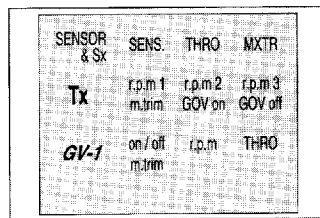

Sensor mounting stay

For 30 engine

For 60 engine

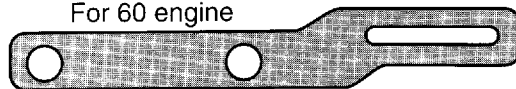

Sensor mounting screws

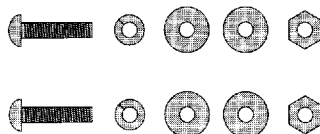

Miniature screwdriver



Nomenclature

Control amp

LCD display panel

Displays the speed and set data.

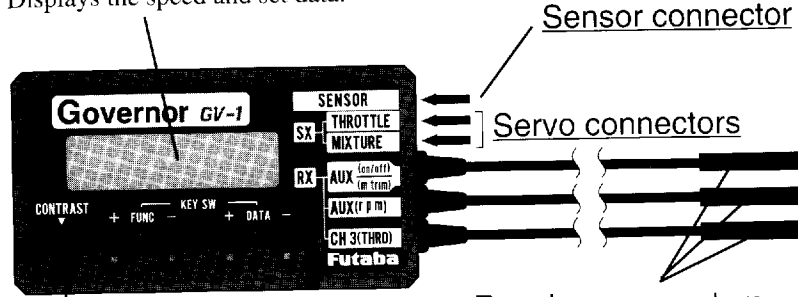

Edit keys

Used to set data. Press with the accessory miniature screwdriver.

LCD contrast trimmer

The display contrast can be adjusted so that the LCD display is easy to read. Adjust the contrast with the accessory miniature screwdriver.

Seal

Stick this seal to the sensor and servo connectors, transmitter switch, etc.

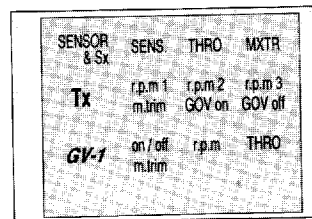

Overview of GV-1 operation

The GV-1 operates from 1000 to 2100rpm main rotor speed. However, the engine must be running at the set speed. The GV-1 turns off the governor when the engine is starting or idling.

*Governor operation = Operation that stabilizes the engine speed at the set speed.

When governor turned on and off by switch (Normal condition)

Setting the switch to the ON position turns on the governor. The following describes this operation.



Governor can be turned on and off by a switch.

- Throttle stick set at least 20% from slow position and engine running at 70% or more of set speed ->->-> ON
- Throttle stick set to maximum slow position ->->-> Remains ON
- Switch set to off position ->->-> OFF

When governor turned on and off by transmitter throttle stick

The data is set so that the governor can be turned on and off with the transmitter throttle stick. The following describes this operation.

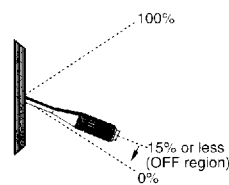

(OFF at slow side)

- Throttle stick set at least 20% from slow side and engine running at 70% or more of set speed ->->-> ON
- Throttle stick held at 15% or more from slow side ->->-> Remains ON
- Throttle stick lowered 15% or more from slow side ->->-> OFF

(Governor operating point)

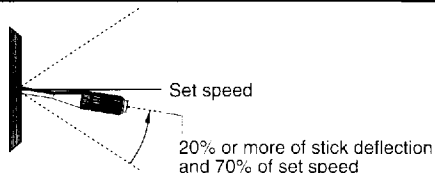

- For safe operation, do not turn on the governor under the conditions shown below. If satisfied while the governor is on, the following conditions will forcibly turn the governor off.

When the governor is off, the transmitter throttle stick controls the throttle servo.

- Engine started while governor switch in ON position.
- Engine speed is 70% or less of set speed and throttle stick is set to 20% or less from slow side after engine started (governor starting only).
- Speed set to 999rpm or less (OFF setting).
- Stick signal is lower than stop position setting.
- Engine stopped, or sensor signal abnormal.
- Throttle stick set 15% or less from slow side (only when function that turns governor on and off by stick is set).

- The following operations do not indicate trouble:

(When engine speed rises above the set speed)

A near-vertical dive may cause the engine speed to rise above the set speed.

(Throttle operation speed and ON/OFF point)

If throttle operation exceeds 70% of the set speed and the rotor speed rises to the set value, the ON/OFF point may seem to differ with the operating speed. Delay operation to smoothen the switching operation causes this and does not mean that the ON/OFF point has changed.

(Deviation from set speed)





The GV-1 stabilizes the engine speed to within +1% of the set speed. For example, if the rotor R.P.M. is set to 1500rpm, the Rotor R.P.M. speed will deviate about +15rpm. However, this poses no problem from the standpoint of practical use.

BEFORE USE



BEFORE USE

Examples

The GV-1 functions can be selected to match the transmitter used. Select the functions by referring to the examples shown below.

	Function			Connection
	Speed switching	Governor on/off	Mixture function	
Example 1	 Three positions CH7(example)	 ON/OFF CH8(example)	None	Sx — Throttle servo Not connected Rx — 2P switch channel 3P switch channel Throttle channel
When used with PCM1024Z				
Example 2	 Two positions CH7(example)	Speed switching position 1 used	None	Sx — Throttle servo Not connected Rx — Not connected 3P switch channel Throttle channel
When used with FF8 or PCM1024Z (without mixture function)				
Example 3	 Two positions CH7(example)	Speed switching position 1 used	 Mixture control used	Sx — Throttle servo Mixture servo Rx — Volume channel 3P switch channel Throttle channel
When used with FF8 or PCM1024Z (with mixture function)				

BEFORE USE

	Function			Connection
	Speed switching	Governor ON/OFF	Mixture function	
Example 4	None Speed set at governor side.	 on/off	None	Sx — Throttle servo Not connected Rx — 2P switch channel Not connected Throttle channel
Example 5	None Speed set at governor side.	 ON/OFF Throttle stick	None	Sx — Throttle servo Not connected Rx — Not connected Not connected Throttle channel
When there is no vacant channel				

BEFORE USE

Mounting the magnet and sensor

Modify the cooling fan and install the accessory magnet and attach the magnetic sensor to the engine at the position shown below.

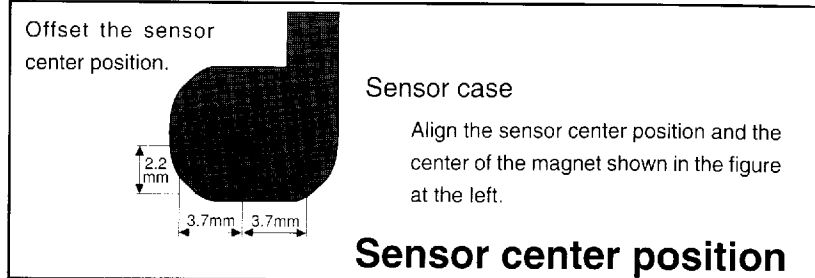
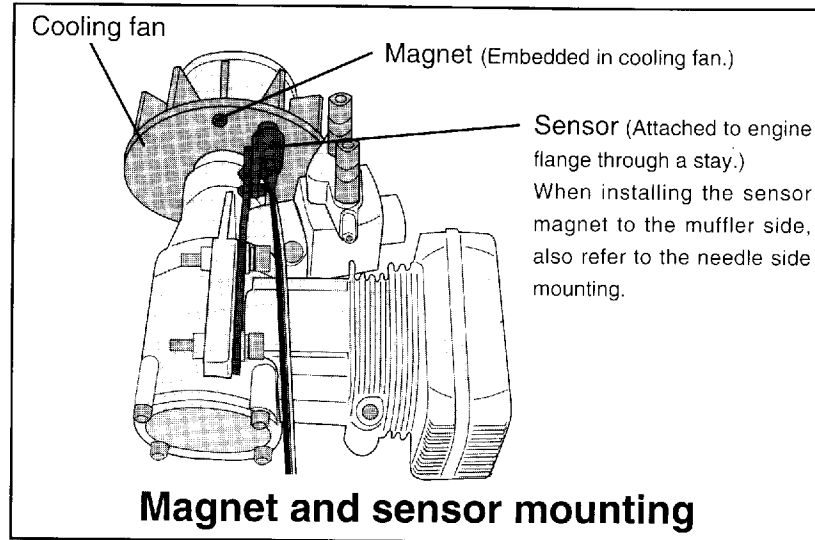

ASSEMBLY & ADJUSTMENT

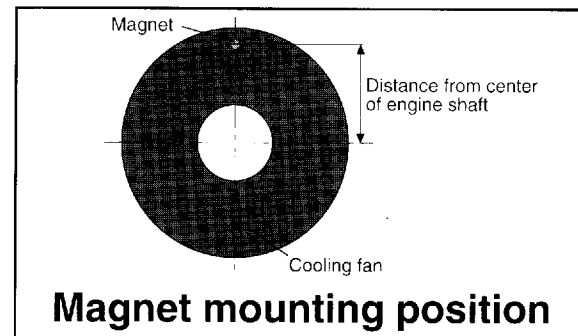
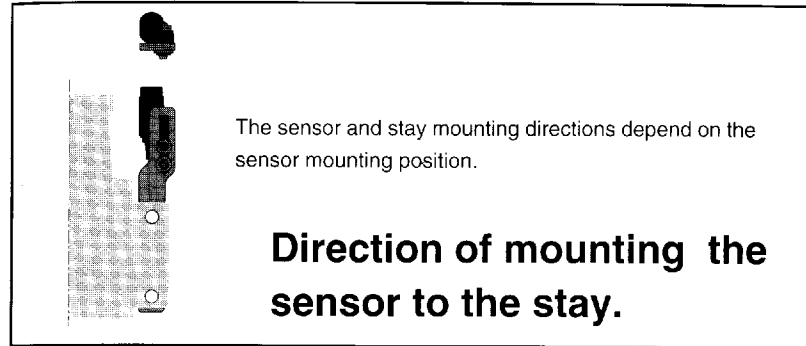

Magnet mounting method

The tables below show the magnet mounting position (example) for each engine.

60 engine		30 engine	
Mounting position	Distance from center of engine shaft	Mounting position	Distance from center of engine shaft
Needle side	27.1-28.8mm	Needle side	22.0-24.0mm

With a Kyosho 60 helicopter, do not use a stay. Mount the sensor directly to the helicopter frame.

ASSEMBLY & ADJUSTMENT

Magnet direction check

(Magnet operating side check)

1 Connect the sensor to the control amp.

2 Connect a battery directly to one of the servo connectors.

3 Press the FUNC+ or FUNC- key until the "sensor percentage" screen is displayed

4 Bring the magnet near the end of the sensor and check the operating side.

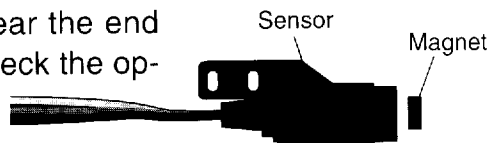
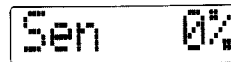
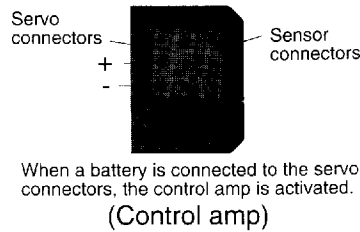

This is the side at which the displayed value increases. Install the magnet with this side facing the sensor. Mark this side of the magnet with a felt tip pen.

Sensor mounting

The sensor mounting method depends on the helicopter and engine.

1 Mount the sensor to the sensor stay. (Temporary assembly)

2 Drill a hole in the fan cover at the part corresponding to the sensor so that the distance between the sensor and magnet can be made 1 to 2mm.

3 Tighten the sensor stay together with the engine mounting flange. (Temporary assembly)

4 Select the mounting method so that the sensor does not touch the frame, or other parts of the helicopter. Temporarily mount the sensor and select the magnet mounting position.

-Install the sensor to the sensor stay using the accessory screws and washers.
-Tighten the sensor stay together with the engine using the engine mount screw.

Magnet mounting

(Cooling fan modification)

1 Drill a hole in the fan at the magnet mounting position.

Make the hole about 4.1mm in diameter and 1.5 to 1.7mm deep.

2 Embed the magnet in this hole in the direction in which an output is obtained.

Use epoxy adhesive that cures in 30 minutes or longer.
Do not use epoxies that contain metal such as JB Weld.

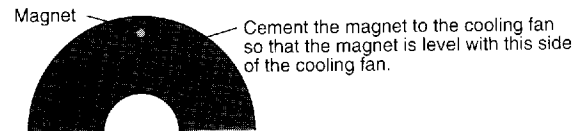

If the cooling fan is unbalanced and vibrates, etc., balance it by mounting the spare magnet to the opposite side of the cooling fan in the opposite polarity (so that it does not output a signal).

Sensor adjustment

- 1 Call the "sensor percentage" screen.
- 2 Adjust the sensor position to obtain a sensor output of at least 60%.

Sen 0%

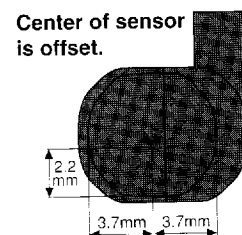
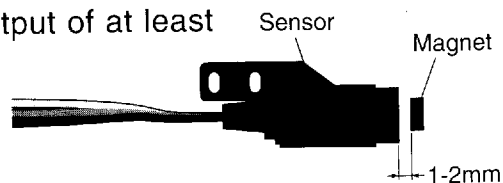

Sensor case

Align the sensor center position and the center of the magnet shown in the figure at the left.

- 3 Complete assembly of the sensor by securely tightening the screws that were temporarily tightened.
- 4 Recheck the sensor output.

GV-1 connections

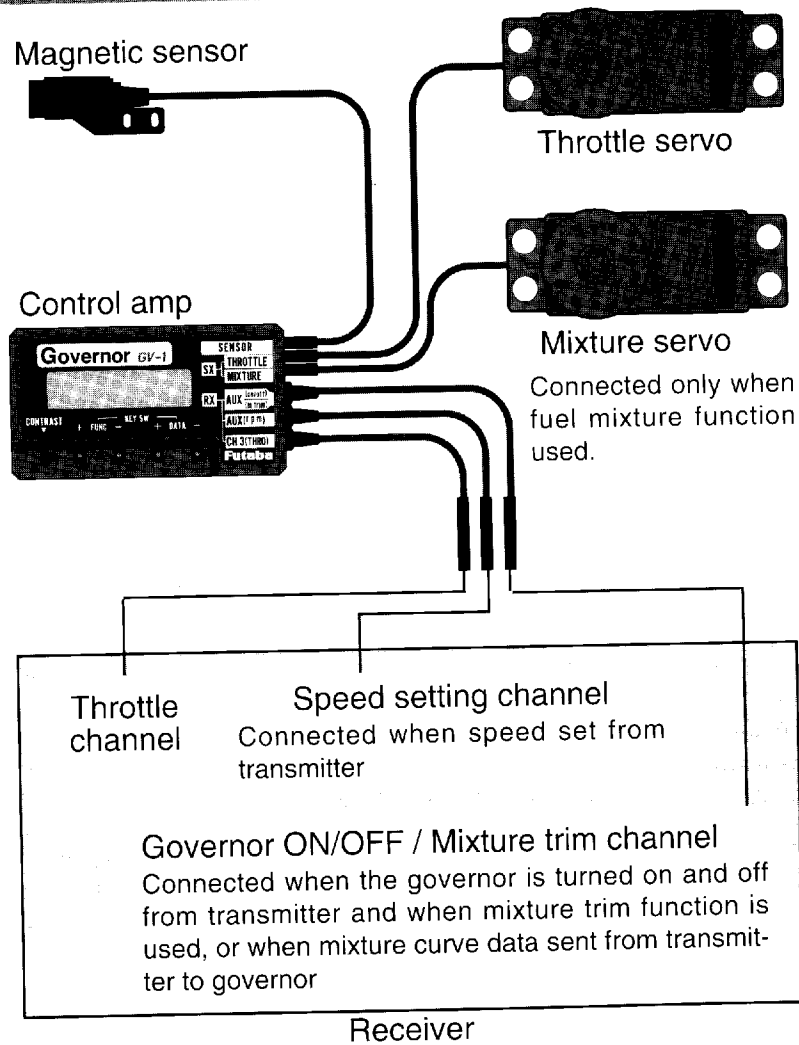

Fuselage setting precautions

Throttle servo linkage precautions

To effectively use the governor, observe the following precautions when connecting the servo linkage.

- Make the servo operating range as wide as possible. Make the throw of the transmitter ATV function, AFR function, and functions as close as possible to 100%. The governor will not operate at throws lower than 50%.
- Do not use the throttle curve. Operate the throttle linearly.
- Fly with the governor turned OFF and adjust the needle so that the engine smoothly reacts to movement of the transmitter stick. If there is a point at which the reaction of the engine is considerably different due to a too rich or too lean mixture, the governor may not operate to its maximum potential..

Fuselage vibration countermeasures

If the helicopter frame is weak, or the engine mount is deformed or not installed properly, the vibrations applied to the engine will increase. Engine vibrations will lead to unstable speed and prevent the governor from maximum performance. Therefore, make sure that the engine is vibration free and that the carburetor is of good liner design because the governor cannot correct engine problems.

Use of a tuned silencer

The use of a tuned pipe type silencer may cause the engine throttle response to be substantially different from that with a normal muffler. Adjust the needle (and pipe length) so that engine speed changes are proportional to the throttle opening. If the engine speed does not change linearly, the governor will not perform satisfactorily with a muffler or a pipe that does not allow the carburetion to be linear.

Control amp mounting

Cushion the control amp with sponge rubber, the same as the receiver and other parts.

LCD display and edit keys

LCD panel

The set-up data can be displayed and the governor operating state can be monitored.

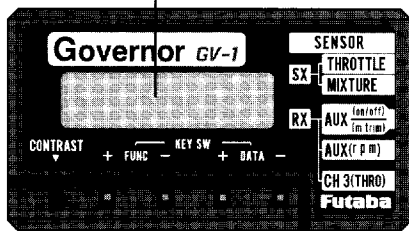

Edit keys

Set-up screen call

The set-up screens can be sequentially called with the FUNC+ and FUNC- keys. The order in which the set-up screens are called, please see the function map.

Data setting

Data is set with the DATA+ and DATA- keys. During data setting, the DATA+ key increases the data and the DATA- key decreases the data. The mode can be selected with either the DATA+ or DATA- key.

Low battery alarm

When the battery voltage drops to 3.8V, "Low Batt" is displayed. When this message appears, immediately stop using the model and recharge the Nicd battery.

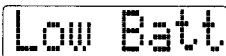

Function map

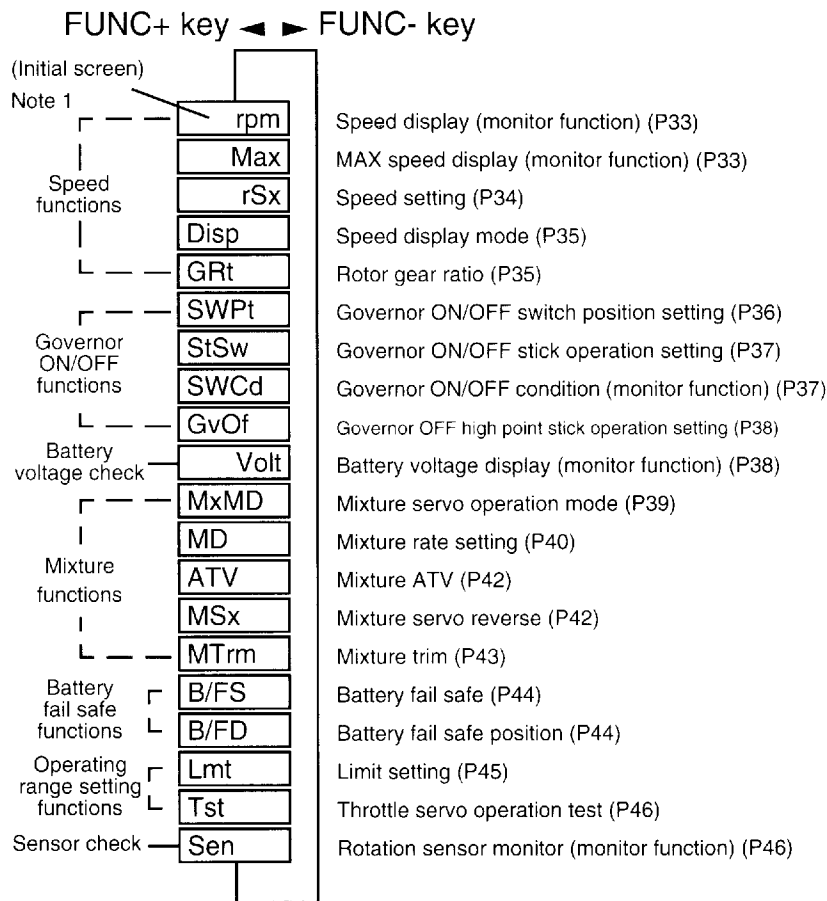

Note 1.

The "Limit Set" screen is displayed only when the power is turned on for the first time after the GV-1 is purchased. Once limit setting is performed, the "Speed display" screen becomes the initial screen.

Initial setting for governor operation

When using the governor for the first time, or when the throttle linkage or the fuselage was changed, always perform this initial setting. The set data are saved even when the power is turned off.

Throttle limit setting

(Governor idle/high/stop points setting)

- 1 Call the "limit set" screen with the FUNC+ or FUNC- key.

Lmt Idle

- 2 Set the throttle stick to the maximum slow position and press the DATA+ or DATA- key.

The "Idle" display stops flashing and changes to a steady light and the idle point is memorized.

- 3 Set the throttle stick to the full high position and press the DATA+ or DATA- key.

The "High" display stops flashing and changes to a steady light and the high point is memorized.

- 4 Set the throttle stick to the engine cut position and press the DATA+ or DATA- key.

The "Stop" display stops flashing and changes to a steady light and the stop point is memorized.

Setting error display

-Set the servo travel to ATV50% or more. If the servo travel is set to less than 50%, "-ERR-" will be displayed. Increase the servo travel and reset the throttle linkage. (Note: The closer to 100% ATV is the best condition)
-Always set the stop point to a position lower than the idle point. If the stop point is set to a position higher than the idle point, "-ERR-" will be displayed. If this occurs, set the stop point to a position lower than the idle point and reset the throttle limit.

Rotor gear ratio setting

(Rotor gear ratio input)

- 1 Call the "rotor gear ratio" screen with the FUNC+ or FUNC- KEY.

Grt 9.70

- 2 Input the gear ratio from the DATA+ or DATA- key.

The rotor gear ratio can be input in 1/100 steps.

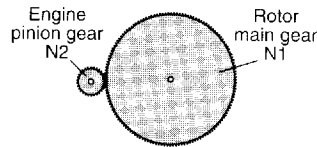

Notes:

-If the gear ratio is not properly set, the set speed and actual engine speed will be different.
-The gear ratio should be given in the helicopter instruction manual. If the helicopter instruction manual does not give the gear ratio, calculate the gear ratio as follows:

$$\text{Gear ratio} = N1/N2$$

Carry values less than 1/1000 to the next whole number.

Speed setting (Set at control amp)

Three speeds can be set. This is standard when the speed is switched by 3-position switch. A 2-position switch and a VR channel can also be used.

- 1 Call the "speed set-up" screen with the FUNC+ or FUNC- key.

1500r52

(When switch used)

(When VR channel used)

- 2 Set the switch to the desired position and set the speed with the DATA+ or DATA- key.

- 2 Set the variable resistor knob to the fully counter-clockwise, center, or fully clockwise position and set the speed with the DATA+ or DATA- key.

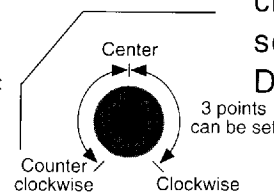

Set the speed of each point by repeating step "2".

The set points can be verified at "rSx" (x=1,2,3) of the display screen.

Note:

When the speed setting channel travel (ATV, AFR) is made 20% or less, points 1 and 3 cannot be set.

Speed setting points

The engine maximum speed range limits the maximum speed setting. Test fly the helicopter with the governor turned off and tach the main rotor R.P.M. while in horizontal flight. This is the maximum R.P.M. that can be achieved with the engine and pitch setup that you are using. Please set the governor maximum speed to approximately 50 R.P.M.'s less. (Example: If 1800 R.P.M.'s is max then set governor to 1750)

The maximum speed can be verified at the MAX. speed display, however this could show some unlocked main rotor condition which is not accurate.

Reference

The transmitter ATV function can also be used to change the point 1 and point 3 speed settings to a certain extent. The amount of this change is proportional to the difference between the point 1 and point 3 set speed and the point 2 set speed. For example, if point 1 is set to 1300rpm and point 2 is set to 1500rpm, and the transmitter ATV is changed from 20 to 100%, the point 1 speed will change from 1460 to 1300rpm. The transmitter ATV function has very little effect on the point 2 speed setting.

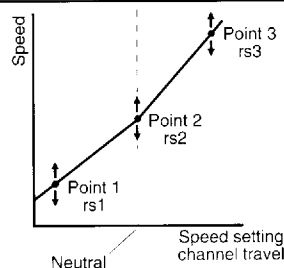

The speed changes linearly on a line connecting points 1, 2, and 3.

Governor ON/OFF operation mode setting

A. When governor turned on and off by on/off switch

- 1 Call the "governor on/off switch position set-up" screen with the  SWPT OFF with the FUNC+ or FUNC- key.
- 2 Operate the ON/OFF switch and verify the ON/OFF directions at the LCD display.
- 3 Use the DATA+ or DATA- key to change the switch ON/OFF directions.

Reference

When you do not want to turn off the governor at the slow position of the throttle stick to perform inverted flight, rolls, and other aerobatics, select INH at the "governor ON/OFF stick operation set-up" (StSw) screen.

B. When using together with speed setting switch

(When using the mixture trim function and when there is no vacant channel)

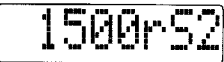
- 1 Call the "speed set-up" screen with the FUNC+ or a FUNC- key. 
- 2 Set the switch to the position to be used as the off position and set the speed to 1000rpm or less with the DATA+ or DATA- key.
- 3 "off" is displayed and the governor can be turned off at that position.

FUNCTIONS

FUNCTIONS

C. When linked with throttle stick

(When there is no vacant channel)

- 1 Call the "governor on/off stick operation set-up" screen with the FUNC+ or FUNC- key. 
- 2 Switch the display from INH to on/off with the DATA+ or DATA- key.
When the stick switch is operated, the display switches from "off" to "on" and the switching point can be checked.
- 3 When the throttle stick is set 15% or less from the slow side, the governor is turned on.

Caution

 Until the start of flight, keep the governor in the off state with the throttle stick at 15% or less from the slow side.



This is the engine starting, etc. mode. If the throttle stick is set to the ON position when the engine speeds exceeds 70% of the set speed, the governor will be unintentionally turned on.

Battery fail safe setting

Warning

 Always perform battery fail safe setting at the governor.

When used, the governor controls the throttle. Therefore, the battery fail safe function normally set in a PCM transmitter is not performed.

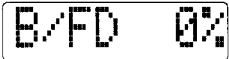
- 1 Call the "battery fail safe" screen with the FUNC+ or FUNC- key. 
- 2 Set the battery fail safe window to "ACT" with the DATA+ or DATA- key. 
- 3 Call the "battery fail safe position" window with the FUNC+ or FUNC- key. 
- 4 Set the throttle stick to the desired position and press the DATA+ or DATA- key.
- 5 The battery fail safe position is memorized.
When the throttle stick is operated, "*" is displayed at the set position and the set position can be verified.

Fail safe data setting

Warning

 Set the throttle channel fail safe function as described below.

When used, the governor controls the throttle. Therefore, the throttle channel fail safe function normally set in a PCM transmitter is not performed.

Transmitter side setting

Use the fail safe function of the channel that turns the governor on and off to set the fail safe position to the point at which the governor is turned off. With this setting, when the system enters the fail safe state, the governor is turned off and the receiver throttle signal is output directly.

Speed sensor output check

⚠ Caution

❗ Check the sensor output not only when installing the sensor but periodically.

Since the magnet rotates at high speed, it is subjected to a large centrifugal force. Check the magnet output and mounting state after about every 10 flights.

- 1 Call the "sensor percentage" screen with a the FUNC+ or FUNC- key. 
- 2 Position the magnet directly below the sensor.
If 60% or more is displayed on the Sen screen, the sensor output is OK.
- 3 Move the magnet away from the sensor.
If 10% or less is displayed on the Sen screen, the sensor output is OK.

If the display is less than 60% when the magnet is directly below the sensor, bring the sensor closer to the magnet so that the 60% or more is displayed. The magnet and sensor gap criteria is approximately 1 to 2mm. If a sensor output is not obtained even when the sensor is brought close to the magnet, the magnet and sensor center positions may have changed.

Description of functions

The following describes, in display order, the functions which can be set or monitored with the GVI. The functions are described from the called state. The functions can be sequentially called with the FUNC (+ or -) keys.

Speed display (monitor function) rpm

This function displays the engine speed or rotor speed.

When the governor is on, "rpm" is highlighted and flashed. When the speed comes within about 2% of the set speed, "rpm" lights steadily. When the speed reaches approximately +1% of the set speed, the display changes to "rpL", which indicates the locked state.

⚠ Caution

❗ When checking the speed, be sure not to get too close to the helicopter.

The display can be switched between engine and rotor with the "speed display mode" set-up screen.

MAX speed display (monitor function) Max

This function displays the maximum engine speed or rotor speed. It can be used to check the engine power. However, the maximum speed when the throttle stick is 95% or more from the high side is memorized. The maximum value is memorized while the power is on.

(Reset method)

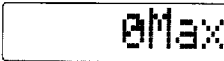
- 1 Hold down the DATA+ or DATA- key for at least 2 seconds, or turn off the power. 

The display can be switched between engine and rotor with the "speed display mode" set-up screen.

Speed setting

rS1~rS3

The speed can be set for three points.

Connect the speed setting input "AUX(r.p.m)" to a receiver vacant channel.

(Set value check)

- 1 Operate the switch (3-position), or variable resistor knob.

1500rS2

The set values are displayed on the LCD screen in rS1->rS2->rS3 (slow->medium->high) order.

(Speed setting method)

- 1 Set the switch or variable resistor knob to the desired position and set the speed of that point by pressing the DATA+ key (accelerate) or DATA- key (decelerate).

-When not using the speed setting channel, set rS2 only. rS1 and rS3 are disabled.

-When using a 2-position switch, set rS1 and rS3 only. rS2 is set to the initial value (1500rpm).

(Setting range) 1000~2100rpm

(Initial value) rS1:1300rpm rS2:1500rpm rS3:1700rpm

Reference

If the speed is set to 1000rpm or less, the display will change to "-Off-" and the governor can be turned off at that switch position.

The engine and rotor displays can be switched with the "[speed display mode]" set-up screen.

Speed display mode

Disp

The speed display mode can be changed. Engine speed display (Eng) or rotor speed display (Rot) can be selected.

(Mode switching)

- 1 The display is switched each time the DATA+ or DATA- key is pressed.

Disp Rot

(Initial value) Rot

Rotor gear ratio

Grt

This function inputs the gear ratio between the main rotor and the engine to display the rotor speed.

(Input method)

- 1 Input the gear ratio by pressing the DATA+ key (increase) or DATA- key (decrease).

Grt 9.70

(Setting range) 3.00~15.00 in 1/100 steps

(Initial value) 9.70

Governor ON/OFF switch position setting

This set-up screen sets the direction of operation of the switch when the governor is turned on and off with the transmitter switch. The governor on/off input "AUX(on/off)" connects to a receiver vacant channel.

SWPt

(Setting direction check)

- 1 Operate the switch.

The "off" or "on" set direction is displayed on the LCD screen.

SWPt OFF

(Changing the direction)

- 1 Change the direction by pressing the DATA+ or DATA- key.

(Initial value) Normal mode

Function priority

The "governor ON/OFF switch position set-up" and "mixture trim" functions cannot be enabled simultaneously. Therefore, when the "governor ON/OFF switch position set-up" function was enabled, always INH the "mixture trim" function. Moreover, always set the "mixture servo operation mode" to the "Gov" mode.

FUNCTIONS

Governor ON/OFF switch operation setting

If the governor is turned on and off by using the throttle stick position, then by selecting. "INH" inhibit it will turn off the governor at the maximum slow position. When this function is set to the side at which on/off switching is performed, when "OFF" is displayed, the governor is off and when "ON" is displayed, the governor is on and can be operated.

StSw

(Setting method)

- 1 Switch the mode by pressing the DATA+ or DATA- key.

StSw INH

(Initial value) INH

Governor ON/OFF condition (monitor function)

SWCd

This function displays the present governor on/off status. When the governor can be operated, "ON" is displayed. This function checks all the conditions for turning the governor on and off.

SWCd OFF

FUNCTIONS

Setting of Governor OFF at high stick position

The governor can be turned off at the high side from the set point. However, this function is only effective when the speed is set to 1600rpm or more. It will not operate even if the speed is set to a value lower than this.

GvOf

(Setting method)

- 1 Set the point by pressing the DATA+ key (increase) or DATA- key (decrease).

GvOf INH

(Setting range) 70~100%

At 100%, the display changes to "INH" and the governor remains on all the time.

(Initial value) INH

Note:

When the governor set speed and the engine speed at the point at which the governor is turned off are considerably different, the speed variation when the engine speed shifts from the governor off point back to the governor on point will be large. Therefore, adjust the off point, or the set speed, so that the governor off point speed and governor set speed are the same.

Battery voltage display (monitor function)

This function displays the present battery voltage.

Volt

When the battery voltage drops to 3.8V, the battery alarm "Low Batt" flashes.

4.9Volt

Low Batt

Mixture servo operation mode

MxMD

The mixture servo must operate in proportion to operation of the throttle servo. When a governor is used, the throttle servo is controlled by the governor. Therefore, the governor must generate the mixture signal.

The mixture operation mode can be selected.

When the "Gov" mixture servo operation mode is selected, the mixture servo operates on a 9-point curve set by the governor. Set the rate of each point with the "mixture rate set-up" function.

The "Dir" mode sets the curve at the transmitter in the governor off state to simplify mixture curve setting. It is used by setting the transmitter fuel mixture control function to "ACT". The curve data set at the transmitter controls the mixture servo. The mixture servo can be operated by copying the mixture curve. The AUX (m.trm) connector connects to the mixture channel. The setting of each point is called from the transmitter with the "mixture rate set-up" function. In this mode, curve data from the transmitter can be set for nine points.

The "Dir" mode is used in mixture curve initial setting. Since operation is linked with the throttle stick and not with the governor, after curve setting, switch to the "Gov" mode. Not all Futaba transmitters have Fuel Mixture Function (FMC), however it is not necessary since the GV-1 has a mixture control function.

(Mode selection)

- 1 Select the mode by pressing the DATA+ or DATA- key.

MxMD Gov

(Initial value) Gov

Note:

Setting the "Dir" mode disables the "governor ON/OFF switch" function. In the "Dir" mode, always set the "mixture trim" function to INH. In the "Gov" mode, when the mixture trim function is ACT, the AUX (m.trm) connector becomes the mixture trim and when the mixture trim function is INH, the AUX (m.trm) connector becomes the governor ON/OFF switch input. Therefore, in the "Dir" mode, when the mixture curve input signal was used, operation is performed with this signal.

Mixture rate setting

MGx/MDx

Each point of the mixture curve can be set. When the "Gov" mode is set with the "mixture servo operation mode" function, "MGx" is displayed and when the "Dir" mode is set with the "mixture servo operation mode" function, "MDx" is displayed at each point. ("x" shows the number of characters of each point.) Nine points can be set.

(Setting method)

- 1 With the governor in the off state, move the throttle stick to the set point.

MD1 ← -15%

At points other than the set point, "->" or "-<" is displayed to indicate the direction of offset from the set point. When the set point is reached, the rate display changes from flashing to a steady light to show that setting is possible.

("Gov" mode)

- 2 Set the rate with the DATA+ key (increase) or DATA- key (decrease).

("Dir" mode)

- 2 Transfer the mixture curve data of that point from the transmitter by pressing the DATA+ or DATA- key.

However, to match the mixture curve data with the transmitter curve data as final servo output, match the "ATV" data of the mixture channel set at the transmitter and the governor side "mixture ATV" data and servo reverse function.

(Setting range) 0~100%

(Initial value) MD1:15% MD2:36% MD3:50% MD4:58% MD5:64% MD6:68% MD7:73% MD8:76% MD9:80%

Mixture ATV

ATV

Sets the mixture servo throw.

Set the operation angle in accordance with the mixture carburetor instruction manual.

(Setting method)

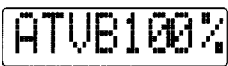
- 1 Operate the throttle stick and select "ATVA" (slow side) or "ATVB" (high side.) 
- 2 Set the steering angle by pressing the DATA+ key (increase) or DATA- key (decrease).

(Setting range) 10~140%

(Initial value) ATVA100% ATVB100%

FUNCTIONS

Mixture servo reverse

MSx

The direction of operation of the mixture servo can be reversed.

(Setting method)

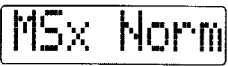
- 1 Switch the direction by pressing the DATA+ or DATA- key. 

(Initial value) Norm

42

Mixture trim

MTrm

Set when you want to use a vacant volume channel to use the mixture servo trim function. "INH" disables the mixture trim function. To use the trim function, set MTrm to "ACT" and connect the AUX (m.trim) connector to the vacant channel you want to use.

Trim operates when the mixture servo is above the neutral position. Adjust the trim servo travel with ATV of the transmitter AUX channel.

(Setting method)

- 1 Set the mode by pressing the DATA+ or DATA- key. 

(Initial value) INH

Functions priority

The "mixture trim" and "governor ON/OFF switch position setting" functions cannot be active at the same time. Therefore, when activating the "mixture trim" function, inhibit the "governor ON/OFF switch position setting" function.

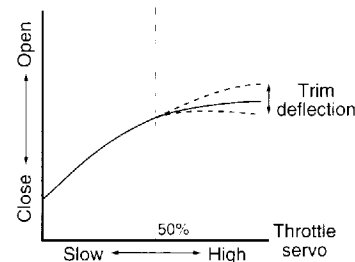

FUNCTIONS

43

Battery fail safe

B/FS

The battery fail safe function can be activated and inhibited.

"INH" inhibits the battery fail safe function and "ACT" activates the battery fail safe function. When activating the battery fail safe function, set the servo position with the "battery fail safe position" function.

(Setting method)

- 1 Set the mode by pressing the DATA+ or DATA- key.

B/FS INH

(Initial value) INH

Battery fail safe position

B/FD

This function sets the throttle position during battery fail safe operation.

When the battery voltage drops to 3.8V, the system enters the battery fail safe mode. Moving the throttle stick to the maximum slow position after battery fail safe operation temporarily resets the battery fail safe function. However, 30 seconds later, the system enters the battery fail safe mode again. Once the system enters the battery fail safe mode, this operation continues until the power is turned off.

(Setting method)

- 1 Move the throttle stick to the desired position and memorize the throttle position at battery fail safe operation by pressing the DATA+ or DATA- key.

B/FD 0%

(Initial value) 20%

(Set point confirmation)

- 1 When the throttle stick is operated, "*" is displayed at the set point and the set point can be confirmed.

Limit set

Lmt

This function sets the governor control range.

Warning

- ! When using the governor for the first time, and when the servo throw was changed, always perform limit setting again.

(Limit setting method)

- 1 When "Idle" is flashing, set the throttle stick to the maximum slow position and press the DATA+ or DATA- key.

Lmt Idle

About 1 second later, "High" begins to flash.

- 2 When "High" is flashing, move the throttle stick to the full high position and press the DATA+ or DATA- key.

Lmt High

About 1 second later, "Stop" begins to flash.

- 3 When "Stop" is blinking, move the throttle stick and cut switch to the engine cut position and press a DATA (+ or -) key.

Lmt Stop

This completes idle/high/stop point setting.

(Initial values) Low:1930us High:1110uS Stop:2070uS

Error display

When adjusting the throttle linkage make sure that ATV and AFR are set to 50% or greater otherwise the GV-1 will not operate and "-ERR-" will be displayed. Also when setting the "Stop" position make sure it is not higher than idle or the "-ERR-" will be displayed.

Throttle servo operation test Tst

The servo operating position set with the "limit set" function can be checked.

(Check method)

- 1 Each time the DATA+ or DATA- key is pressed, the throttle servo moves to the Idle->High->Stop point set position.

Tst Idle

Rotation sensor monitor (monitor function)

The rotation sensor signal level can be checked.

Sen

(Monitoring method)

- 1 Bring the magnet near the sensor.

Sen 0%

The signal level is displayed on the LCD screen. If the display is 60% or more, the speed can be normally picked up. If less than 60% is displayed, adjust the sensor position.

Governor
GV-1

REFERENCE

Specifications and ratings are subject to change without prior notice.

Specifications

- Control system: Digital advanced control
- Speed pick-up: Direct detection of engine rotation by magnetic sensor
- Control resolution: 0.1Hz (+6rpm: engine speed)
- Speed stability accuracy: 1%
- Control response: 20mS
- Speed control range: 1000~2100rpm (rotor speed)
- Speed setting: Key input (10 turns step) Transmitter setting (1 turn step)
- Display: 8 characters dot matrix liquid crystal display
- Mixture curve: 9 points settable
- Operating voltage range: DC 3.8V~6.0V
- Current drain: 40mA (at 4.8V, including sensor)
- Operating temperature range: -10~+50 degree C
- Operating humidity range: 10%RH~90%RH (However, no condensation)
- Size: 56.5x30.5x16mm (body), 7.5x10x16mm (sensor)
- Weight: 34g (body), 4g (sensor)

Glossary

The Glossary gives the definition and the number of the page that describes the related function for the symbols used in this manual.

2P	2-position (switch)	
3P	3-position (switch)	
A		
ACT	Activate	
AFR	AFR function	
ATV	ATV function	P42
AUX	Spare channel.	
B		
B/FS	Battery fail safe	P44
B/FD	B/FS position setting	P44
C		
CH	Channel	
CONTRAST	Contrast adjustment	
D		
DATA	Data input key	P24
DC	Direct current	
Dir	Direct mode	P39
Disp	Speed display function	P35
E		
-ERR-	Data setting error display	
F		
FUNC	Function selection key	P24
G		
Gov, GOV	Governor	
Governor	Governor	
GRI	Rotor gear ratio	P35
GV-1	Model No. of this governor	
GvOf	Governor off high point stick position operation setting	P38
H		
High	High point	P45
I		
Idle	Idle point	P45
INH	Inhibits operation	
K		
KEYSW	Edit key	
L		
LCD	Liquid crystal display	
Lmt	Limit setting function	P45
Low Batt	Battery alarm	
M		
m.trim	Mixture trim	
Max	MAX speed display function	P33
MD	Mixture rate setting function	P40
MG	Mixture rate setting function	P40
MIXTURE	Fuel mixture	
MSx	Mixture servo reverse	P42
MTm	Mixture trim	P43
MxMD	Mixture servo operation mode	P39
MXTR	Mixture	
N		
Norm	Normal side	
O		
on	on	
off	off	
P		
PCM	Pulse code modulation	
R		
Rev	Reverse side	
RH	Relative humidity	
rpm, r.p.m.	Speed (revolutions)	
rS1, rS2, rS3	Speed setting position	
RX	Receiver	
S		
Sen	Rotation sensor monitor	P46
SENSOR	Sensor	
Stop	Stop point	P45
Stsw	Governor on/off stick operation setting	P37
SWCd	Governor on/off condition	P37
SWPt	Governor on/off switch position setting	P36
SX		
SX	Servo	
T		
THRO, THROTTLE	Throttle	
Tst	Throttle servo operation test	P46
Tx	Transmitter	
V		
Volt	Unit of voltage	
VR	Variable resistor	

REFERENCE

*Please copy and use.

GV-1 PARAMETERS SHEET

Helicopter: _____ Date: _____
 Engine: _____

Parameter	Initial value	Set value	Remarks
Speed 1 (rS1)	1300rpm	rpm	
Speed 2 (rS2)	1500rpm	rpm	
Speed 3 (rS3)	1700rpm	rpm	
Speed display (Disp)	Rotor		
Rotor gear ratio (GRt)	9.70		
Mixture trim (MTm)	INH		
Stick ON/OFF mode (StSw)	INH		
Governor high side off (GvoF)	INH		
Mixture rate			
	MD1	15%	%
	MD2	36%	%
	MD3	50%	%
	MD4	58%	%
	MD5	64%	%
	MD6	68%	%
	MD7	73%	%
	MD8	76%	%
	MD9	80%	%
Mixture servo reverse (MSx)	norm		

REFERENCE

REPAIR SERVICE

Before requesting repair, read this instruction manual again and recheck your system. Should the problem continue, request repair service as follows:

Describe the problem in as much detail as possible and send it with a detailed packing list together with the parts that require service.

- Symptom (Including when the problem occurred)
- System (Transmitter, Receiver, Servo's and model numbers)
- Model (Model name)
- Model Numbers and Quantity
- Your Name, Address, and Telephone Number.
- Dated Proof of Purchase (For Warranty Claims)

Please read the warranty card supplied with your system. When requesting warranty, please send the card along with some type of dated proof of purchase.

If you have any questions regarding this product, please consult your local hobby dealer or contact the Futaba Service Center. The address and telephone number are listed below. (For U.S.A.)

Address (For U.S.A.)
Futaba Corp. of America
4 Studebaker
Irvine, CA 92618 (714) 455-9888

REFERENCE

50

FUTABA CORPORATION

• Makuhari Techno Garden Bldg., B6F 1-3 Nakase, Mihama-ku, Chiba 261-01, Japan
Phone: (043) 296-5119 Facsimile: (043) 296-5124

FUTABA CORPORATION OF AMERICA

4 Studebaker, Irvine California 92618, U.S.A.
Phone: 714-455-9888 Telex: 23-0691227 Facsimile: 714-455-9899

©FUTABA CORPORATION 1997,02

REFERENCE

51